

THE PROPERTY OF THE DRAWING IS ESTABLISHED BY LAW. IT IS FORBIDDEN TO PRODUCE OR SHOW IT TO THIRD PART. WITHOUT A WRITTEN AGREEMENT.

Item	Name	Q.ty
1	CA.L.1810.1000	1

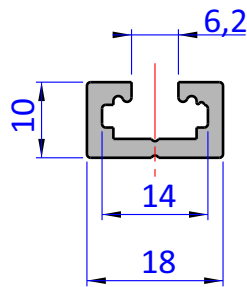
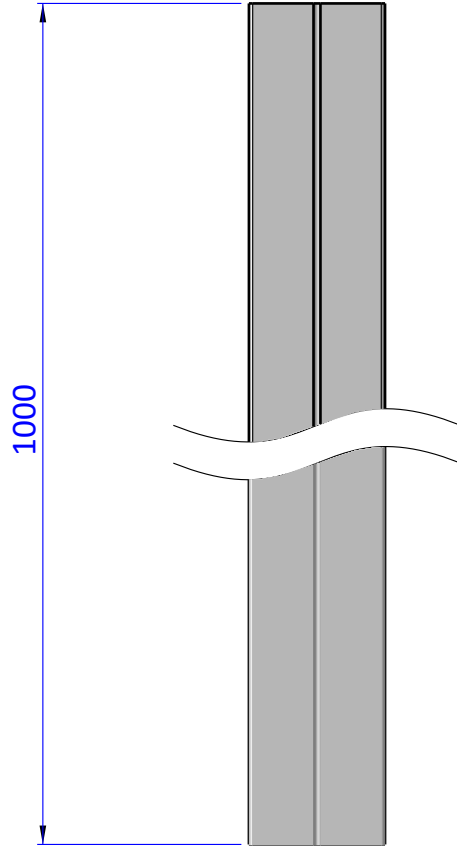

DESIGNED FROM		REVIEW
FPS Automation		A
DATE	WEIGHT	
09/03/2020	0,267kg	
CODE		
CA.L.1810.1000		

Format A4

UNI 936-76

GENERAL TOLERANCE

UNI - ISO 2768

CLASSE f

DESCRIPTION

CA.L.1810.1000